

FLAT NOZZLES FOR FIXED INSTALLATION

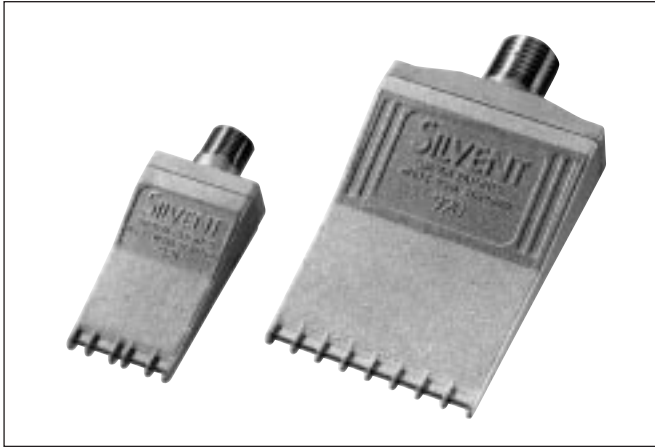

Silvent 920 and 921 are flat nozzles designed to generate a broad and efficient band of air. They are outstanding for use wherever a wide but thin striking surface is required. Flat nozzles are suitable for most areas of application, such as: drying, transporting, cooling, cleaning etc. These nozzles are often used in manifold systems, providing silent and highly efficient air knives. The 920 and 921 are made of zinc. Their exhaust ports are protected from external forces by flanges. Both nozzles fully comply with OSHA safety regulations. Patented.

Additional information in tab: Accessories

REPLACE OPEN PIPE OF DIAMETERS:



3 - 6 mm

1/8" - 1/4"

BENEFITS

Reduces the noise level - 14 - 24 dB(A)

Decreases air consumption - 15 - 55 %

Safety nozzles - Meet OSHA standards

ACCESSORY

ADJUSTABLE SWIVEL JOINT



An adjustable swivel joint for setting the direction of the air cone. The joint enables easy fine-tuning of the blowing angle without affecting other fixed equipment. Correct adjustment of the blowing angle results in a lower noise level and increased efficiency.

DIMENSIONS

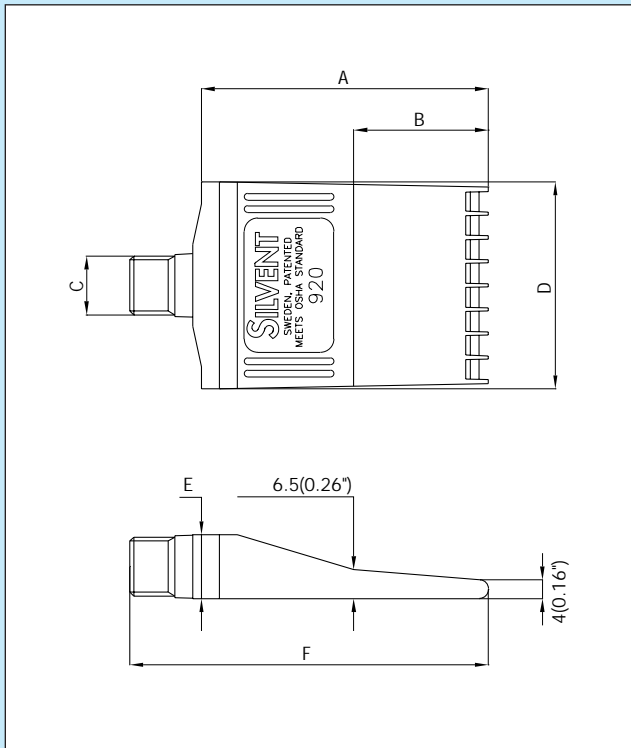

* 920A - Male thread 920B - Female thread

PRODUCT INFORMATION

ORDER NO./MODEL		920A	920B	921
A	mm	64	64	44
	"	2.52	2.52	1.73
B	mm	32	32	22
	"	1.26	1.26	0.87
C*	BSP	1/4"	1/4"	1/8"
	NPT	1/4"-18	1/8"-27	1/8"-27
D	mm	46.3	46.3	23.9
	"	1.82	1.82	0.94
E	mm	14.3	14.3	11
	"	0.56	0.56	0.43
F	mm	80	80	55
	"	3.15	3.15	2.17

Replaces open pipe	mm	6	6	4
	"	1/4	1/4	1/8
Air consumption	Nm ³ /h	30	30	17
	SCFM	17.7	17.7	9.7
Sound level	dB(A)	81	81	80
Blowing force	N	5.5	5.5	3.0
	Oz	19.4	19.4	10.6
Max. temp.	°C	-20/+70	-20/+70	-20/+70
	°F	-4/+158	-4/+158	-4/+158
Weight	g	120	120	38
	lbs	0.26	0.26	0.084
Nozzle material	Zinc			

TECHNICAL SPECIFICATIONS AT VARIOUS PRESSURES

Models:
007

-- Variable position

Pressure psi	Air consump. scfm	Force oz	Sound level dB(A)
40	4.9	4.7	74.2
60	7.7	7.9	78.7
80	10.5	11.1	81.3
100	13.2	14.2	82.8
120	15.9	17.4	83.7

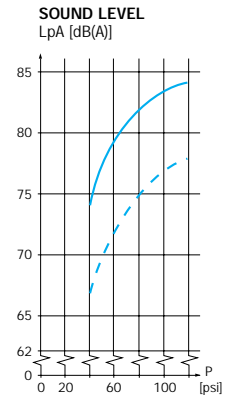
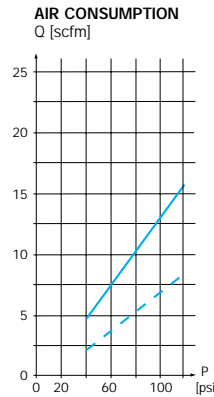
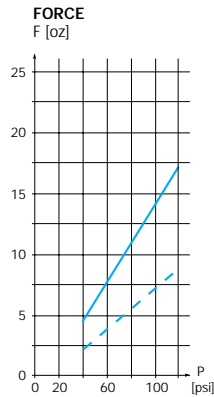

Models:
007 Z, 008

-- Variable position

Pressure psi	Air consump. scfm	Force oz	Sound level dB(A)
40	5.5	5.4	72.0
60	8.2	8.6	76.8
80	11.1	11.8	79.7
100	13.8	15.0	81.6
120	16.6	18.3	82.6

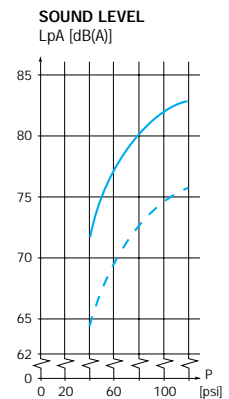
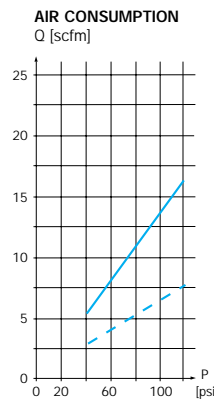
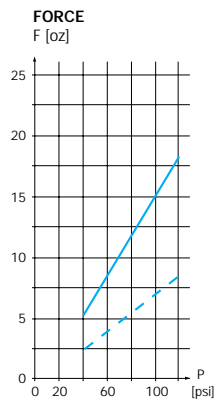

Models: 0071, 0072, 011, 100, 200,
208, 209, 210, 211, 215, 216, 217,
218, 220-280, 221-281, 292, 293,
5005, 501, 2120, 2121

Pressure psi	Air consump. scfm	Force oz	Sound level dB(A)
40	7.2	6.8	74.3
60	8.8	10.1	77.8
80	12.5	13.3	80.5
100	15.2	16.7	82.8
120	17.9	20.1	84.9

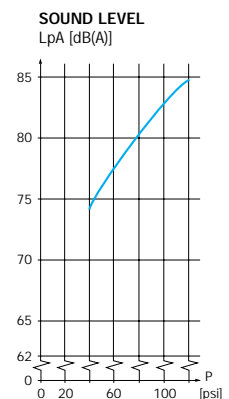
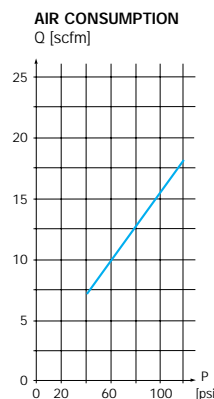
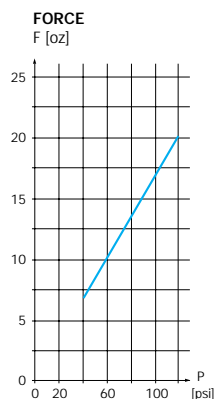

Models:
220F-280F, 294, 920

Pressure psi	Air consump. scfm	Force oz	Sound level dB(A)
40	10.8	10.4	75.1
60	15.4	16.2	79.3
80	20.0	22.1	82.5
100	24.6	27.8	85.0
120	29.2	33.7	87.0

